

# VELOCITY



1070 mm



1120 mm



680g

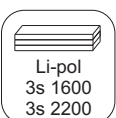

Li-pol  
3s 1600  
3s 2200

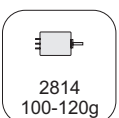

2814  
100-120g



11/4.7  
12/4.7

V1.0

## Stavebnice obsahuje:

- \* EPP díly
- \* podvozek
- \* sáček s příslušenstvím
- \* carbon. táhla

## Carbon list:

- \* 5x1x1000 ... 2x
- \* 5x1x250 ... 1x
- \* 3x1x550 ... 2x
- \* 3x1x250 ... 1x
- \* 3x1x200 ... 1x
- \* 2.5x1.5x200 ... 4x
- \* 3x0.5x125 ... 2x
- \* 3x0.5x75 ... 2x
- \* 1.8x55 ... 2x
- \* 1.8x140 ... 1x
- \* 1.8x165 ... 1x

## Další díly:

- \* stavitelná koncovka 1.8 ... 4x
- \* kul. kloub + šroubek ... 8x
- \* šroub M3x15 ... 2x
- \* matice M3 ... 2x
- \* matice uzavřená M3 ... 2x
- \* podložka prům. 3mm ... 2x
- \* vrut 2.9x6 ... 2x
- \* vrut 2.9x9 ... 4x
- \* motorová přepážka ... 1x
- \* sada pák ... 1x
- \* třmen podvozku ... 2x
- \* držák bačkorek ... 2x
- \* výztuha Sop př.3 ... 2x
- \* kolečka podvozku ... 2x

## Sada pák - rozpis dílů:

1. deska podvozku
2. třmen podvozku
3. páky křidélek
4. páky serva křidélek
5. páka Vop
6. páka Sop
7. páky serva Vop+Sop
8. ostruha

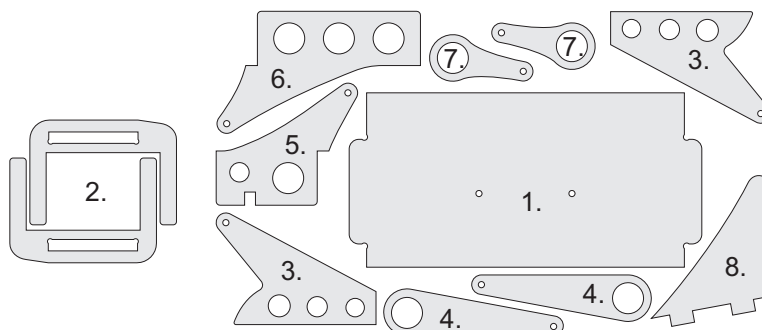

## Dále budete potřebovat:

- \* skalpel
- \* křížový + plochý šroubovák
- \* pinzetu
- \* malé kleště ploché a kulaté
- \* CA lepidlo střední + řidké, aktivátor
- \* 10cm prodlužovací servokabe
- \* smrkový papír 120-180zr
- \* tužku

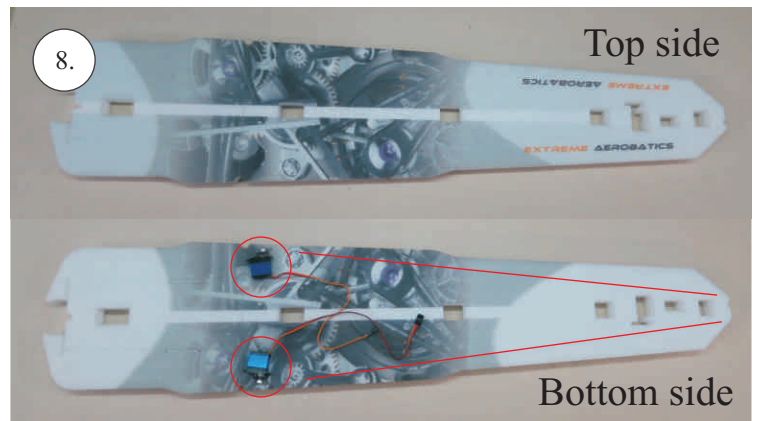
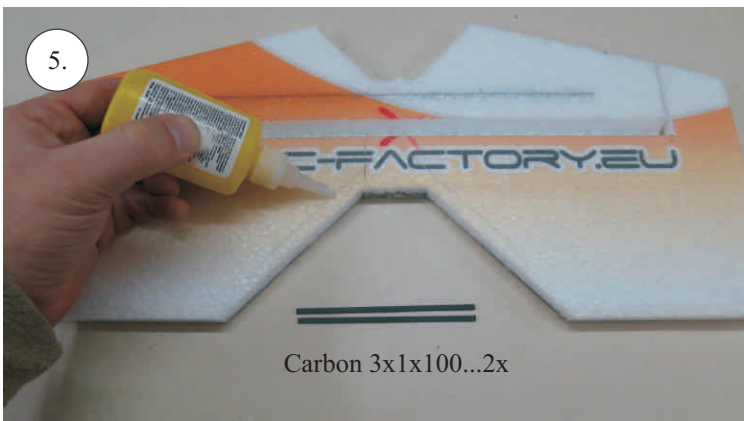
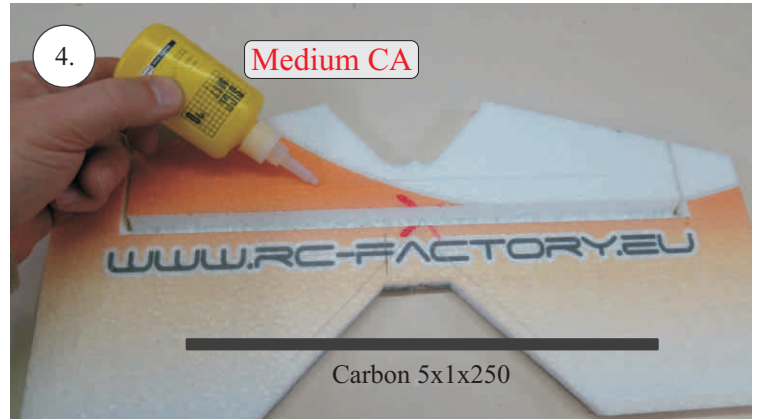
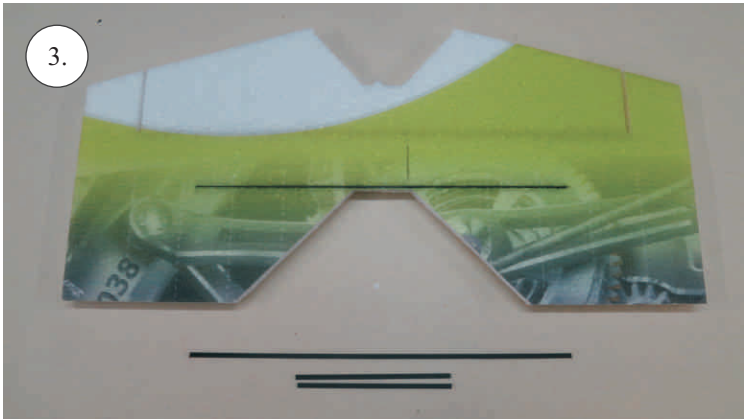
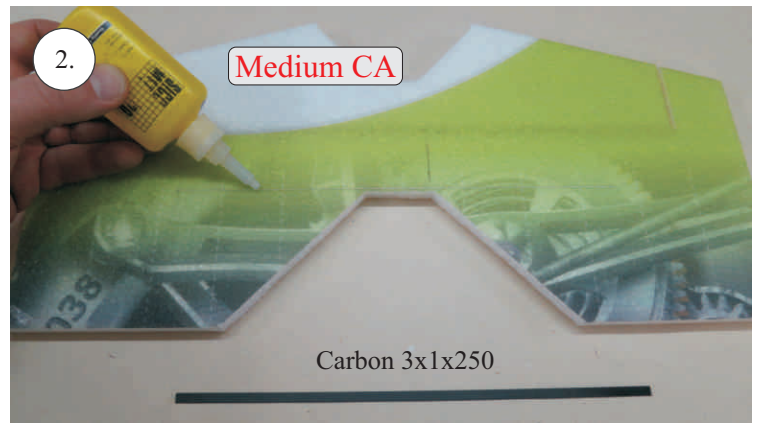
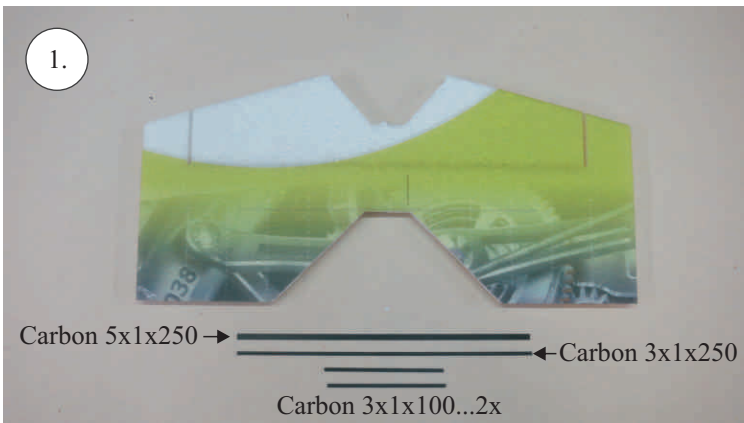



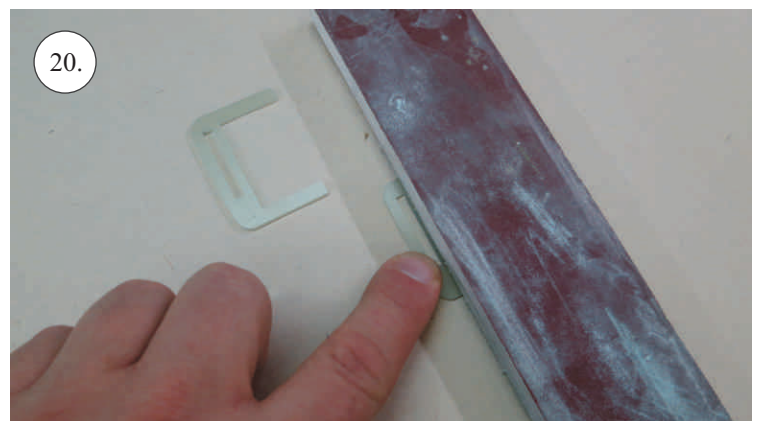
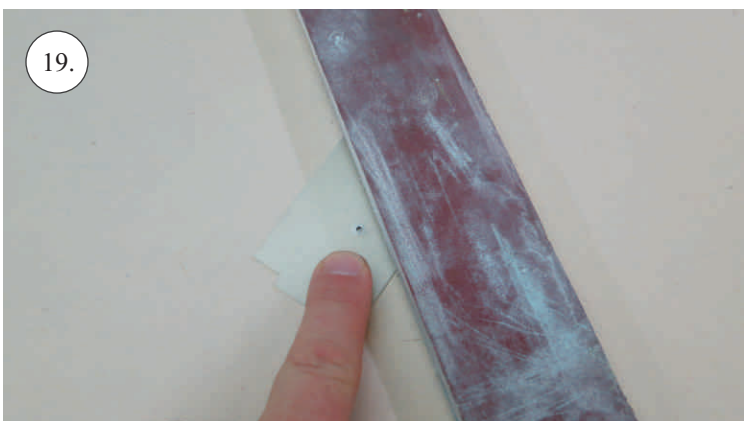
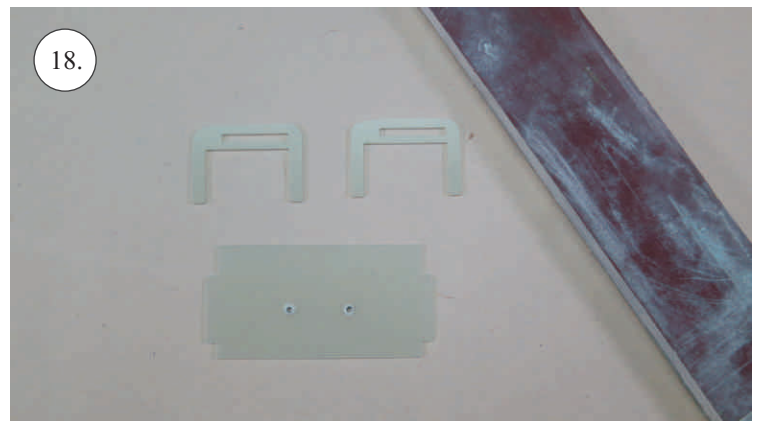
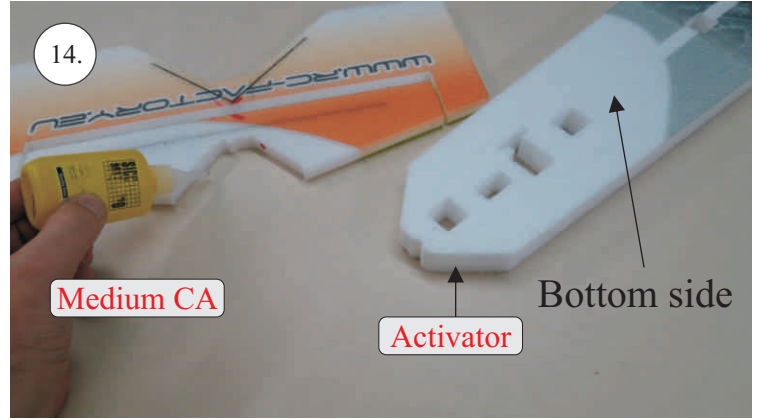
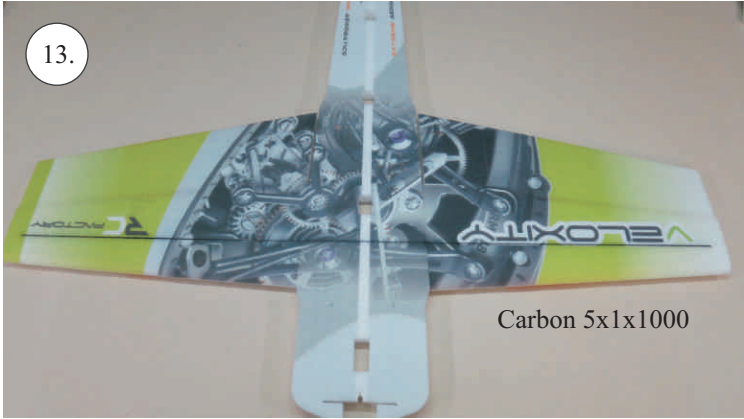
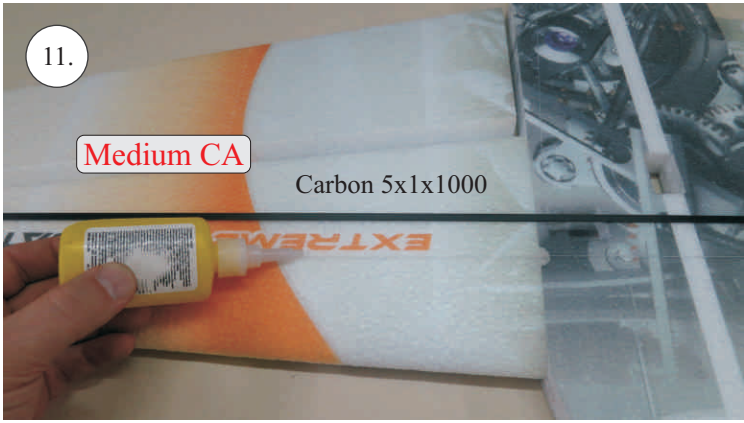

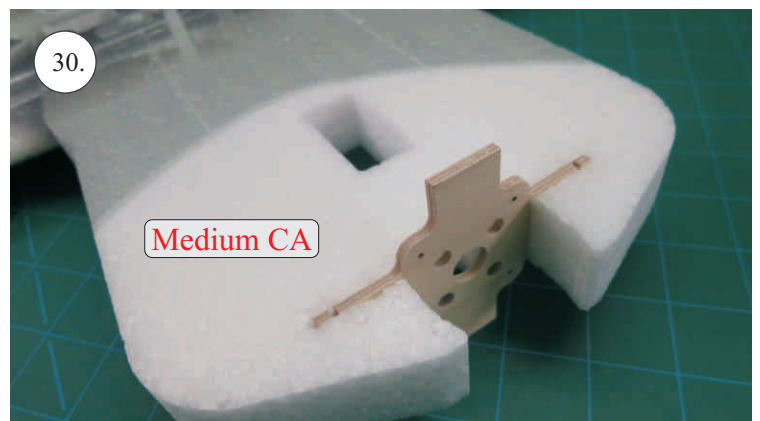
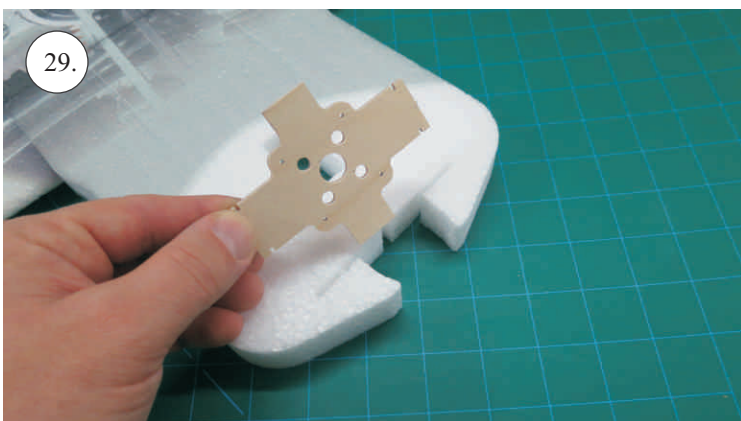
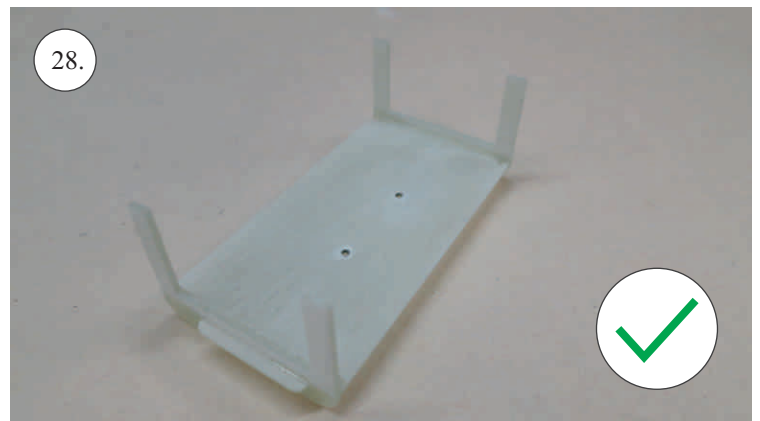
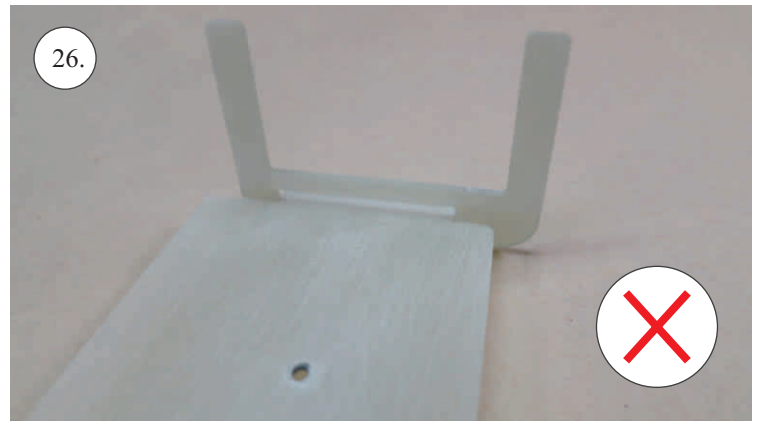
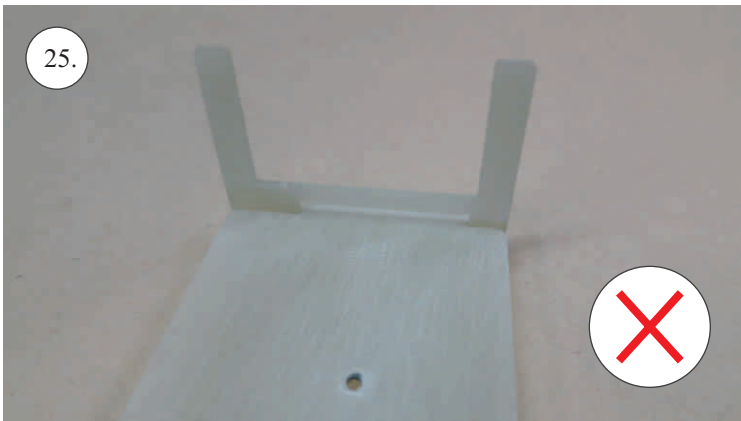
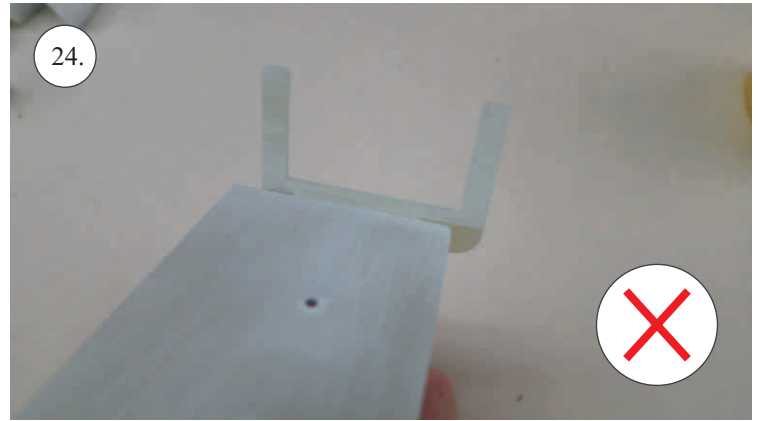
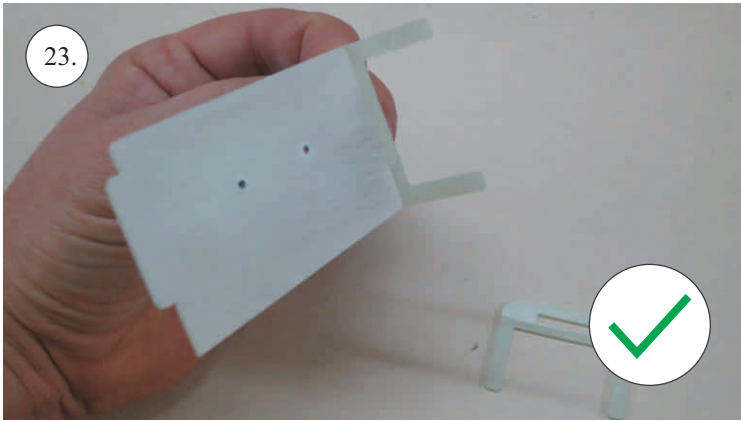
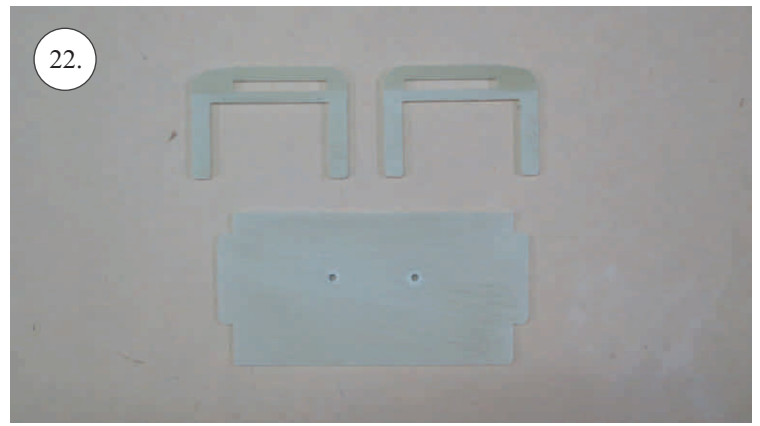
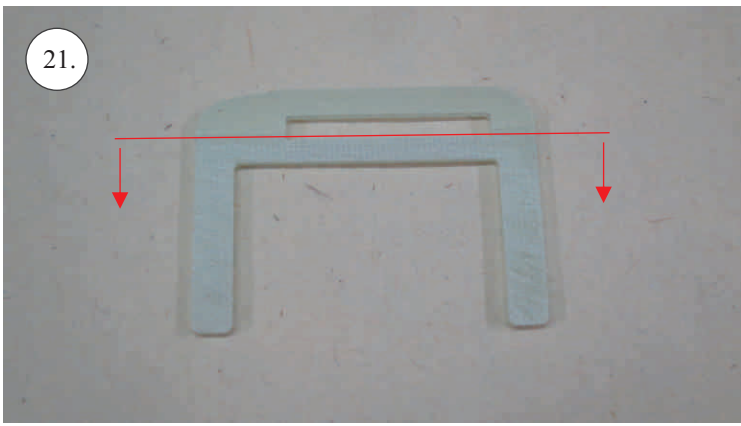



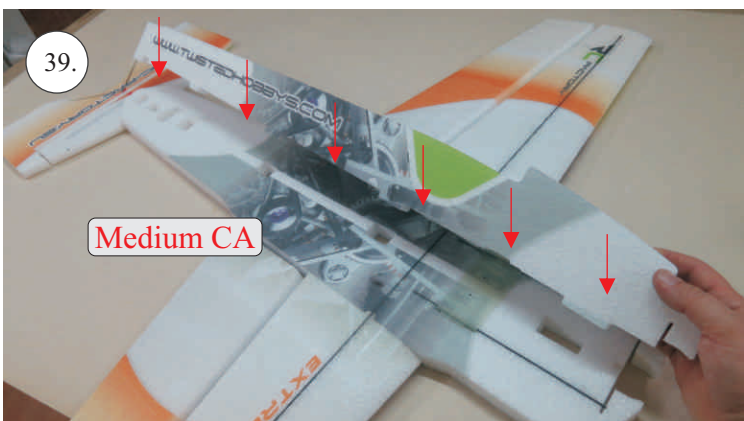
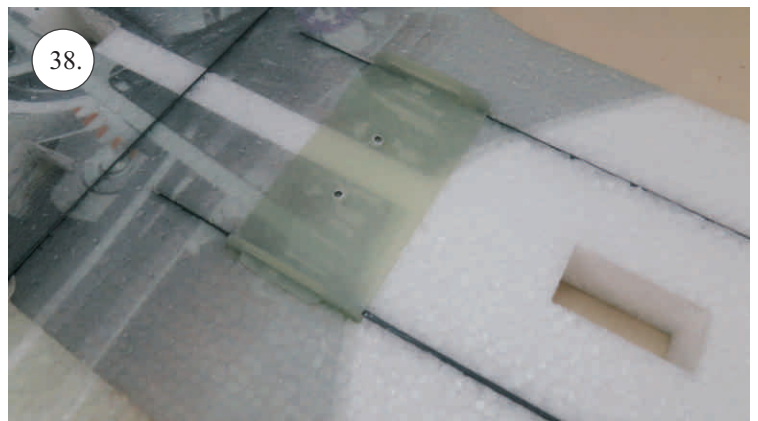
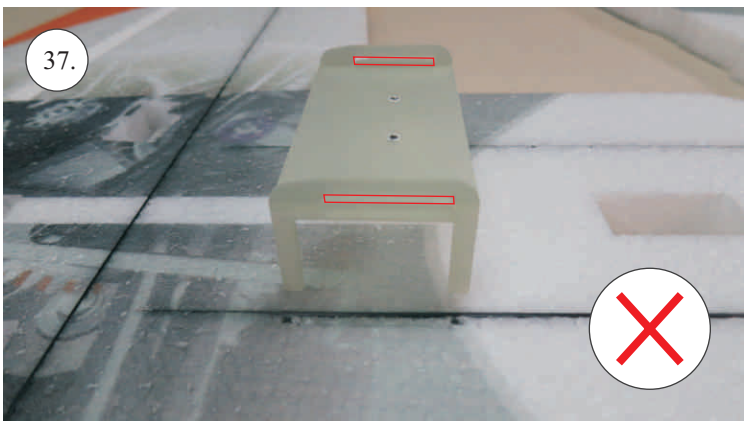
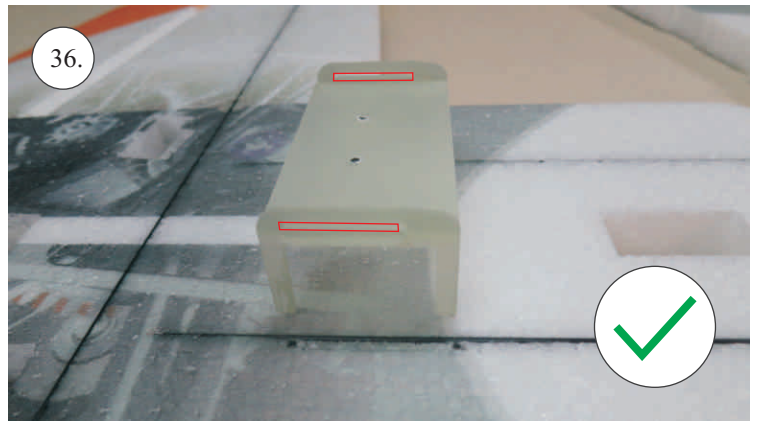
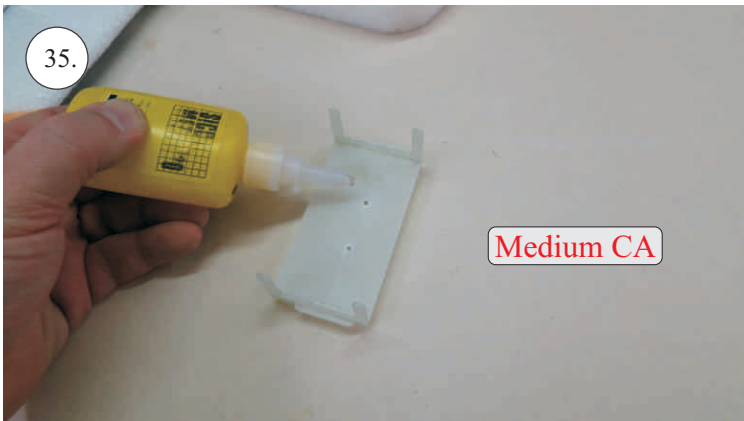
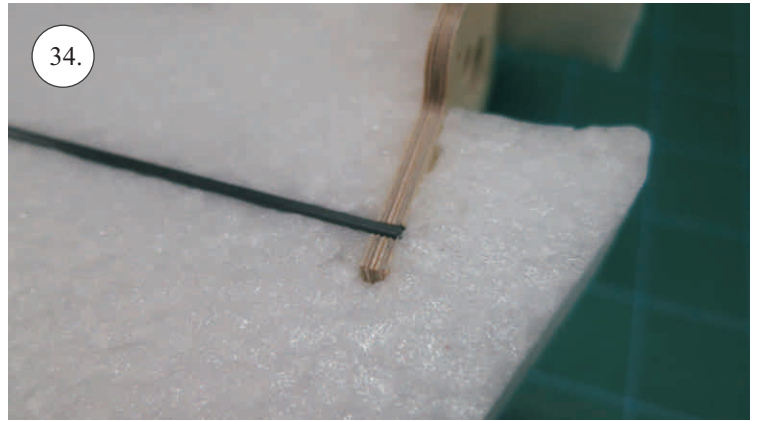
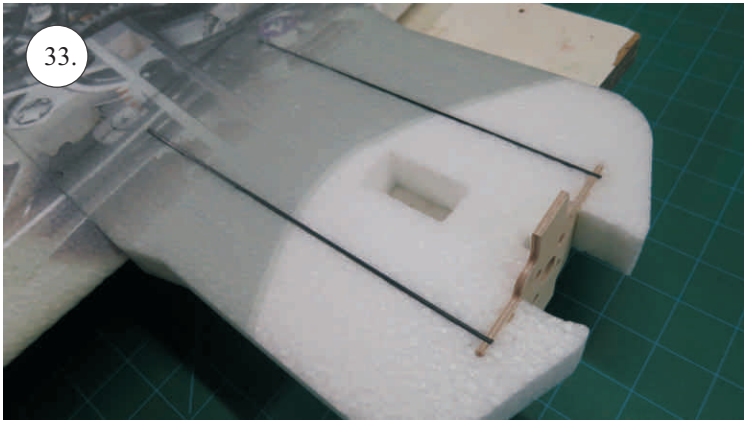
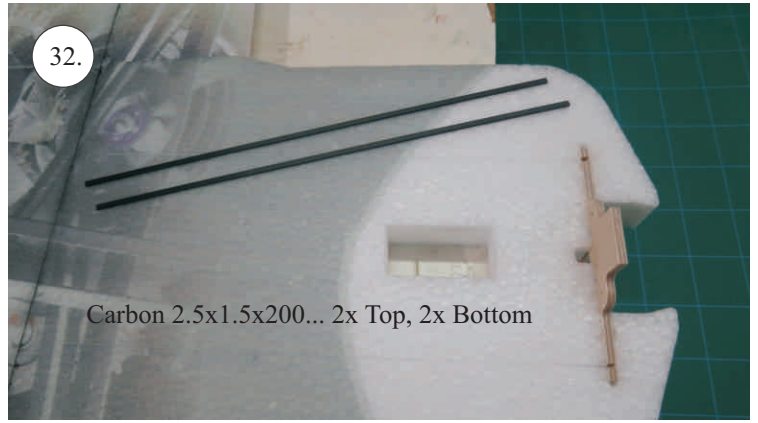
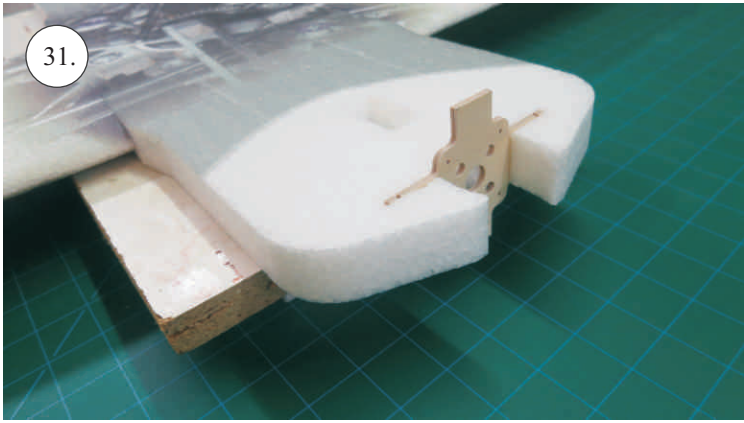



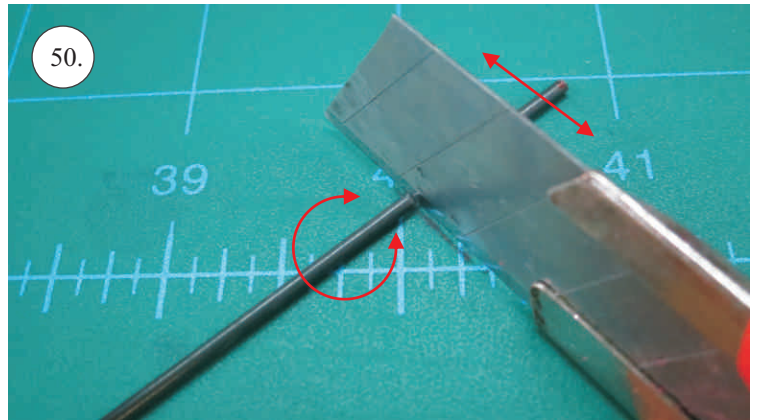
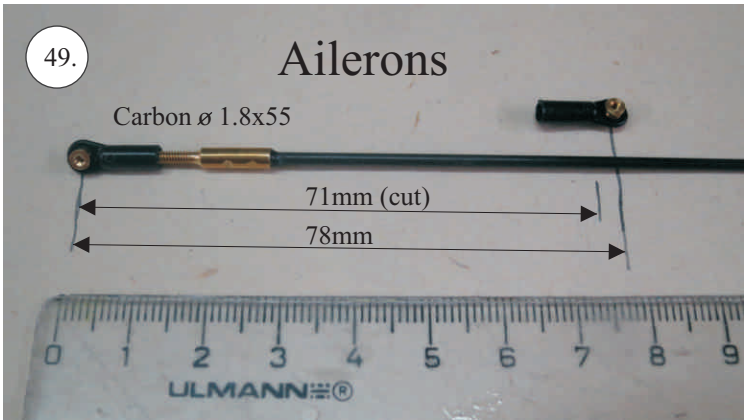
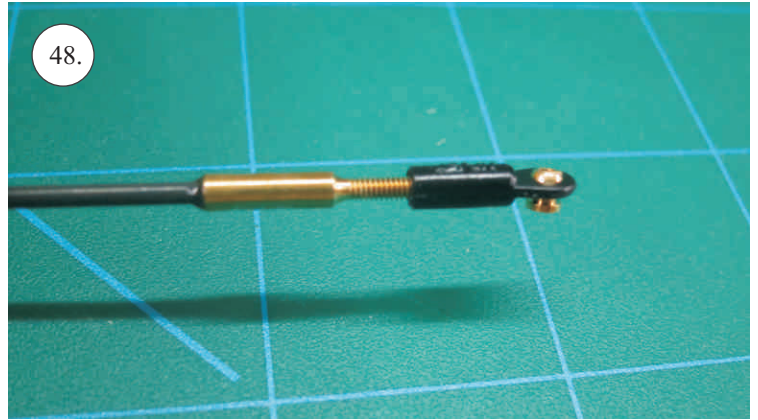
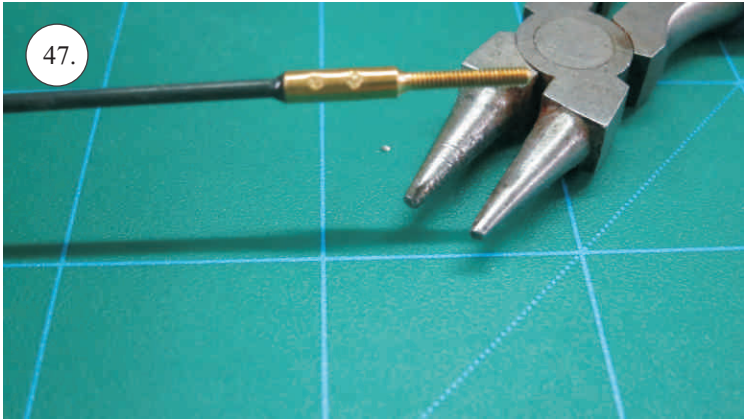
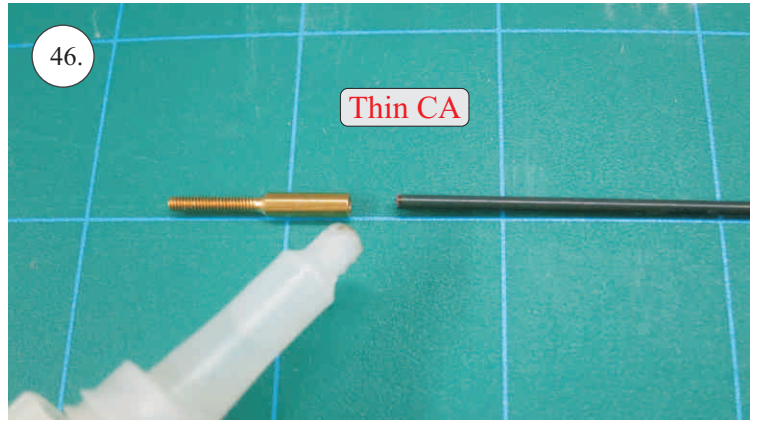
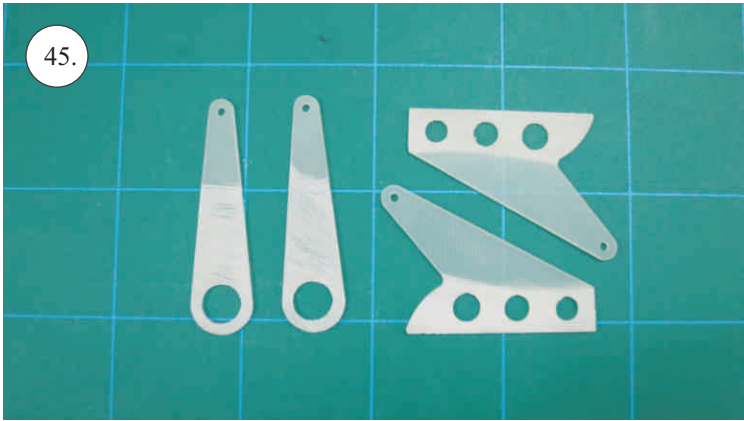
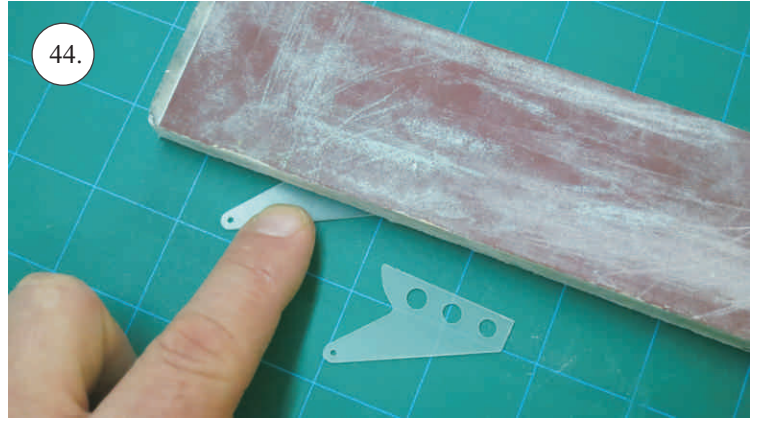
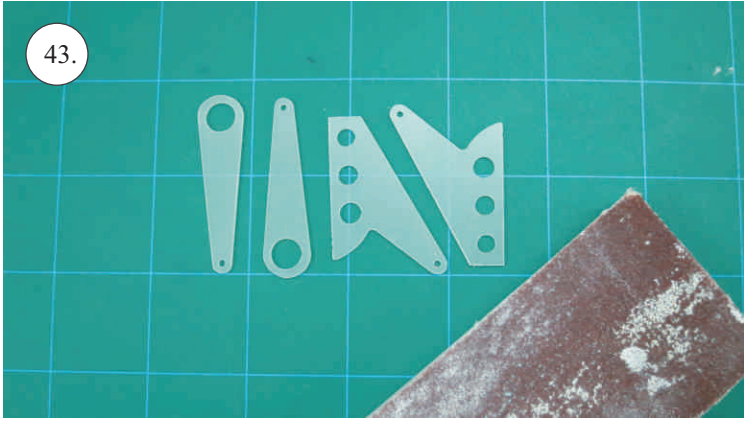
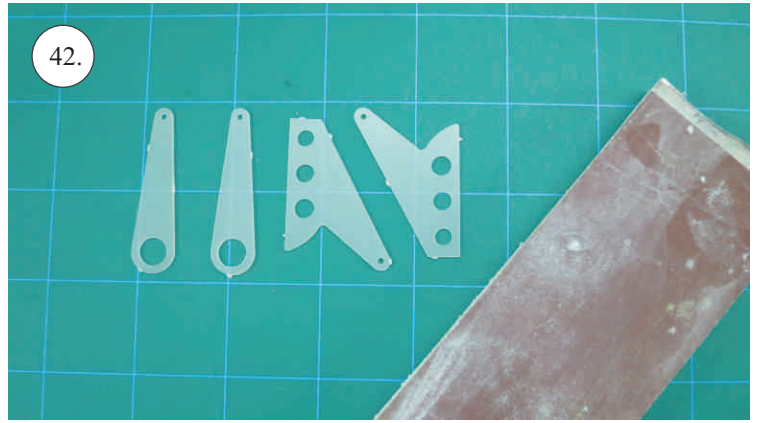
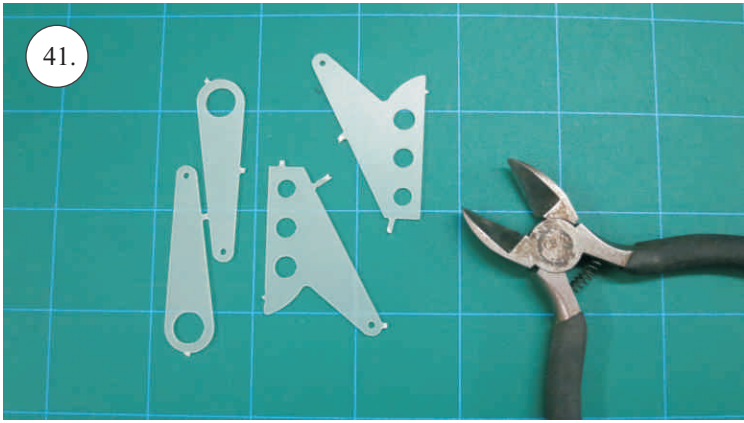



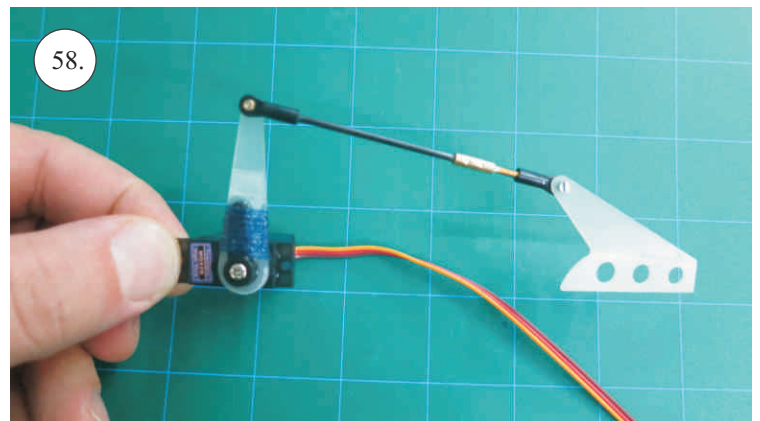
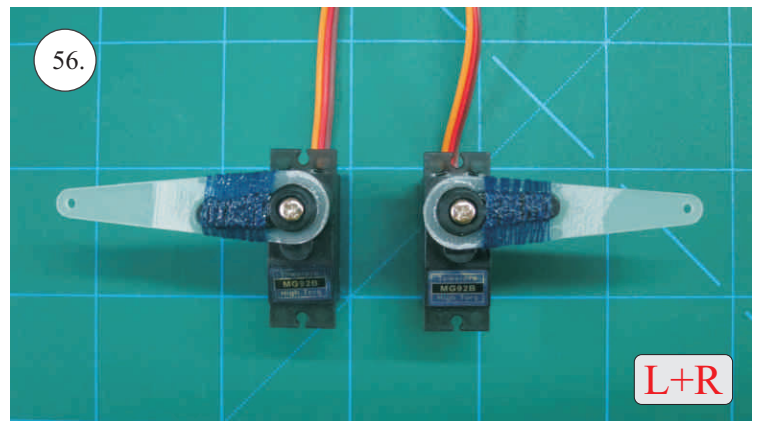
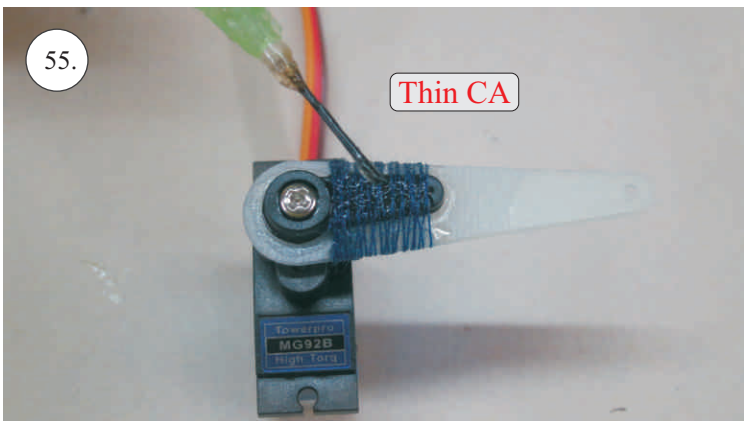
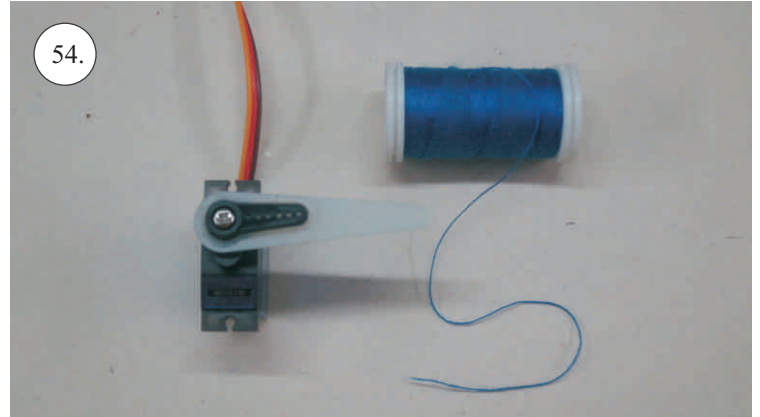
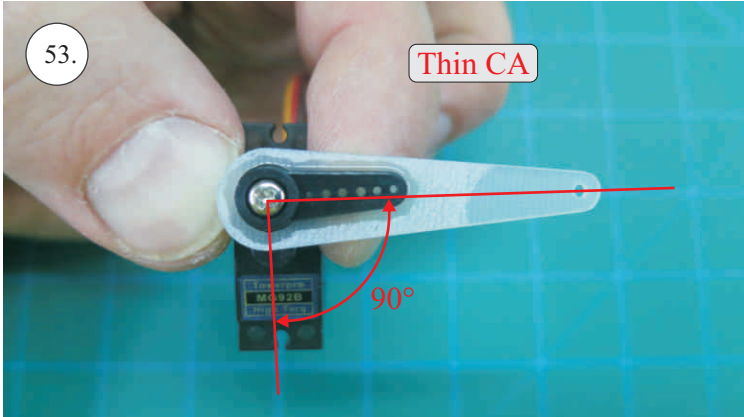
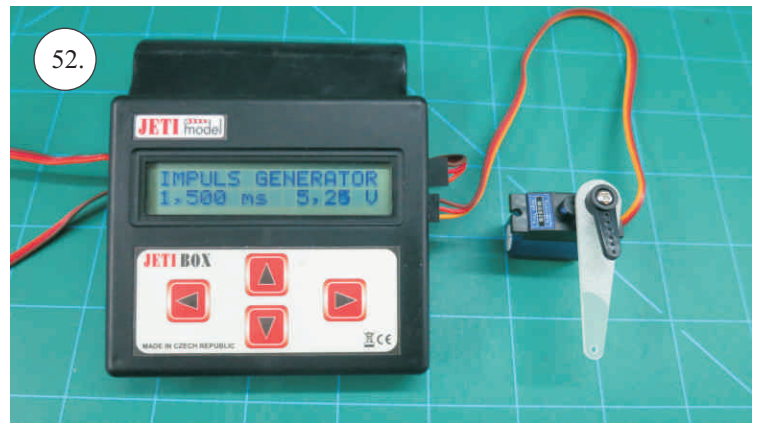
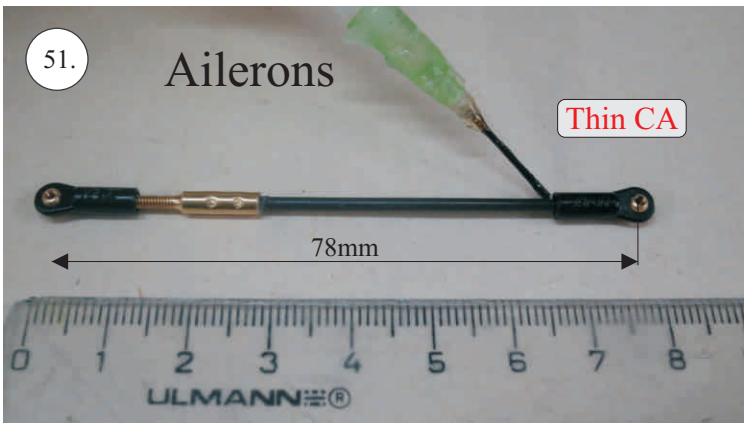



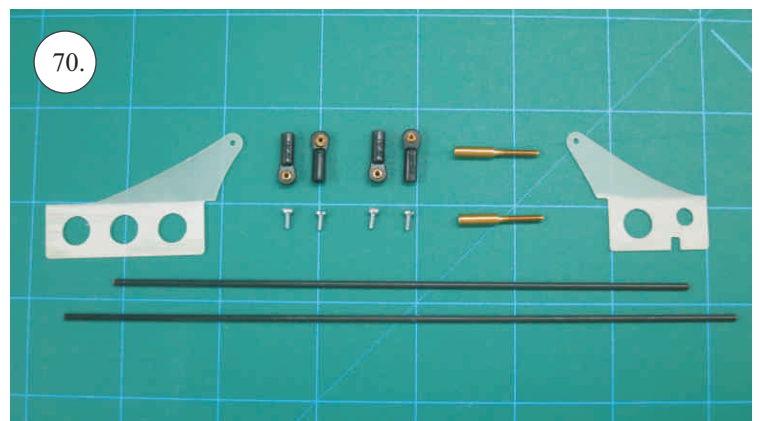
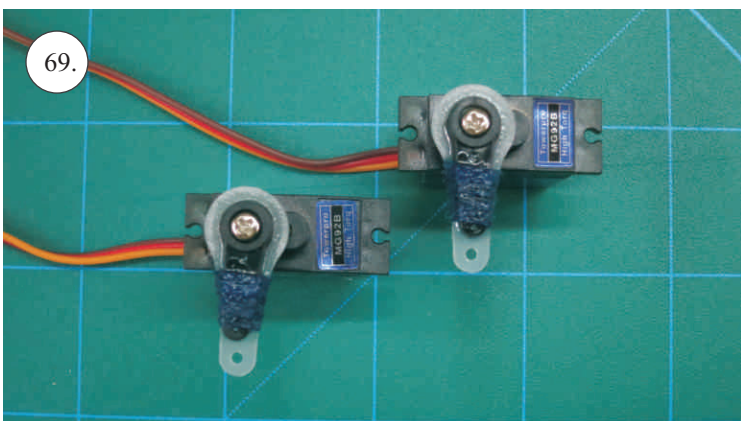
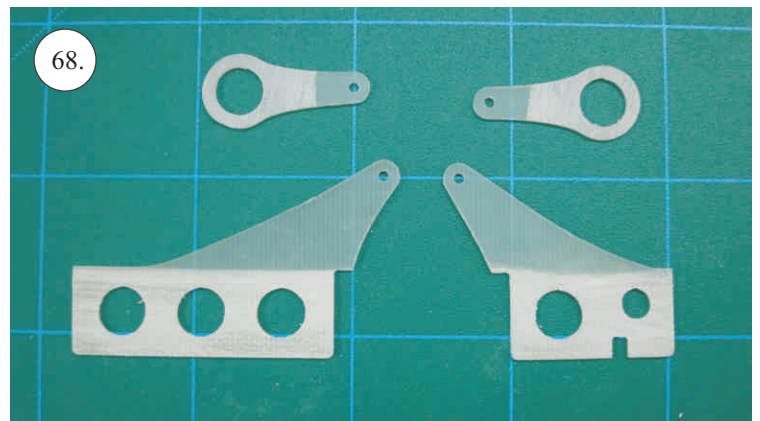
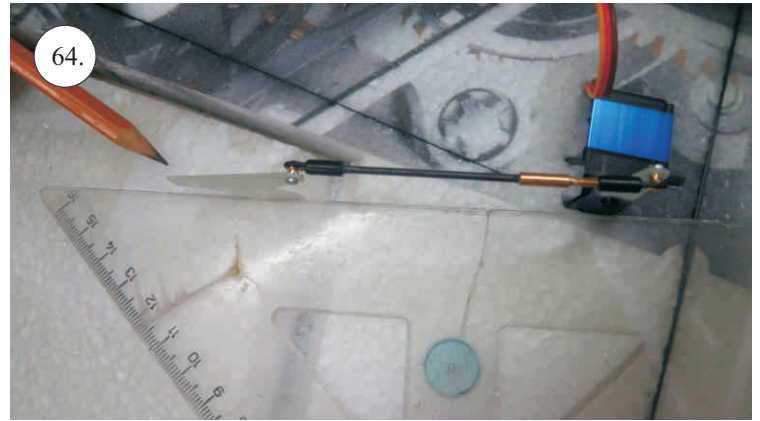
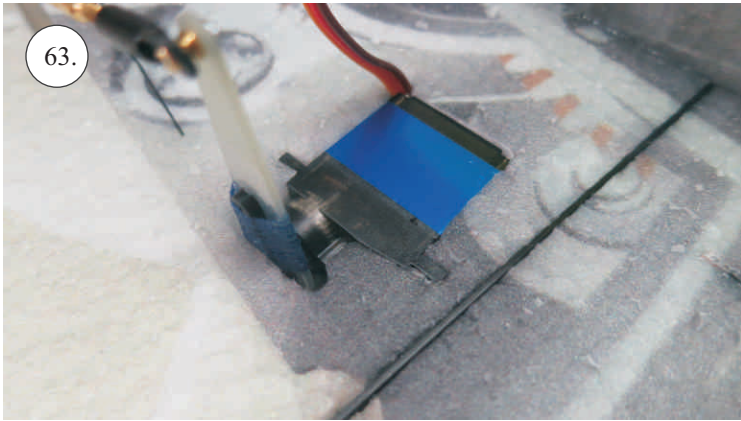
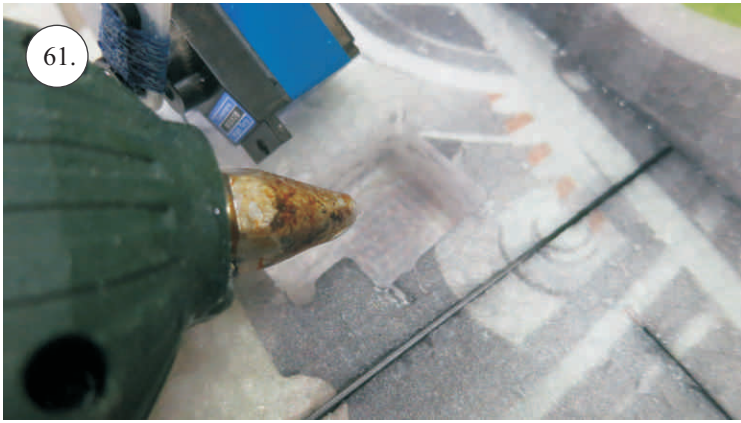



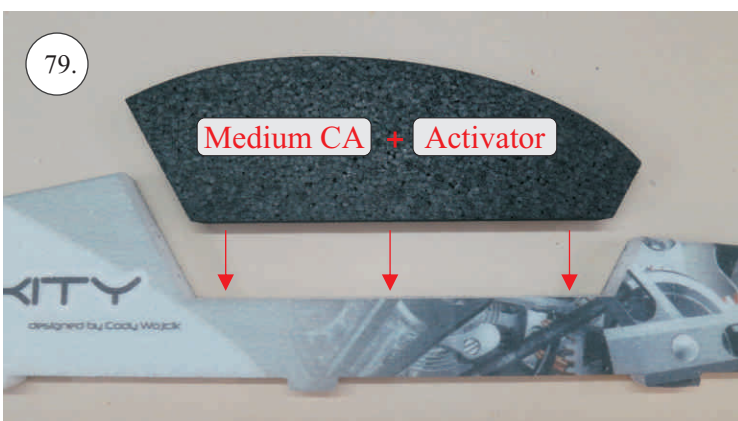
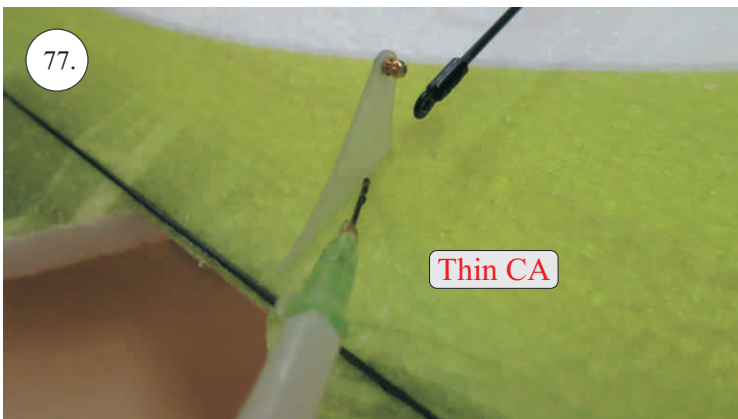
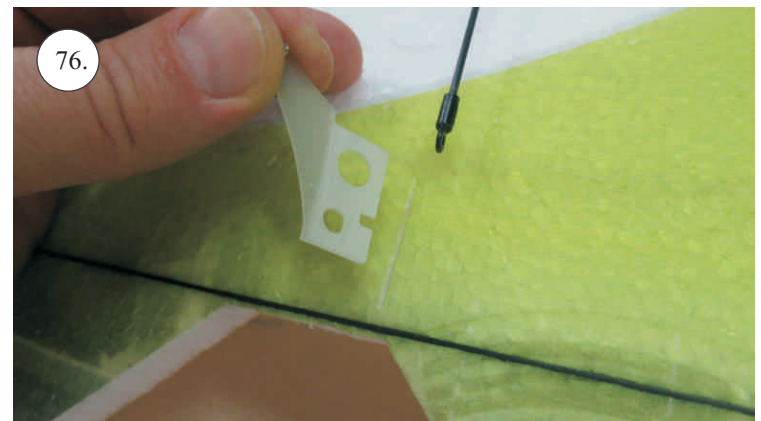
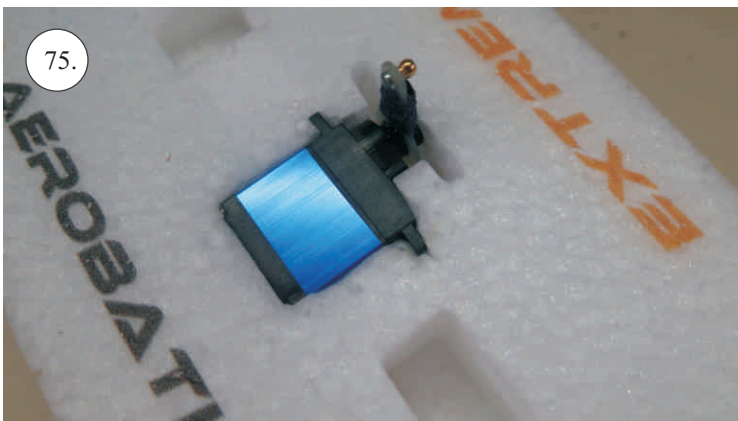
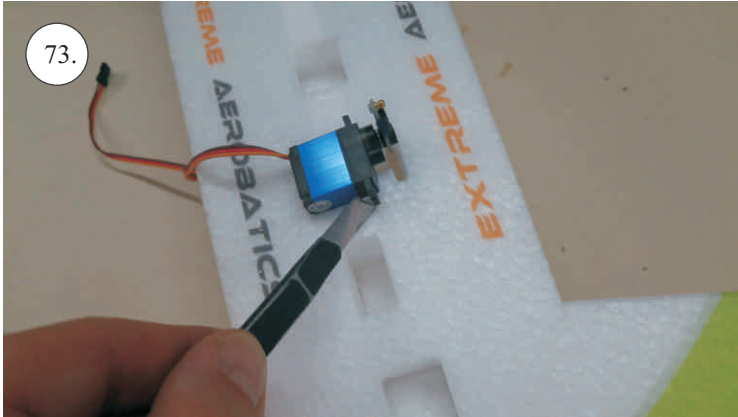
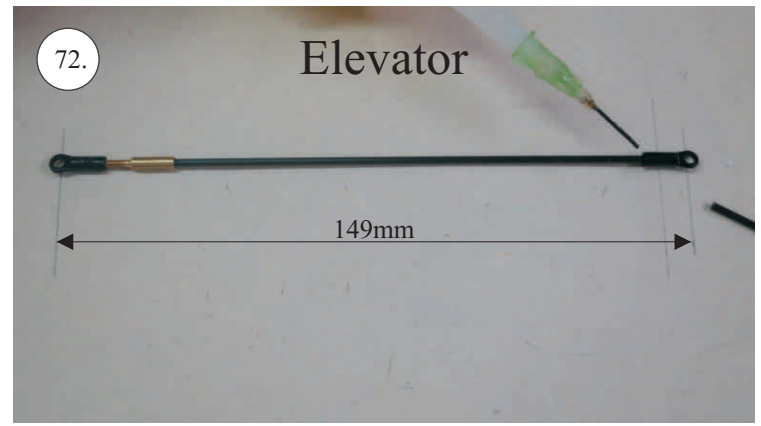
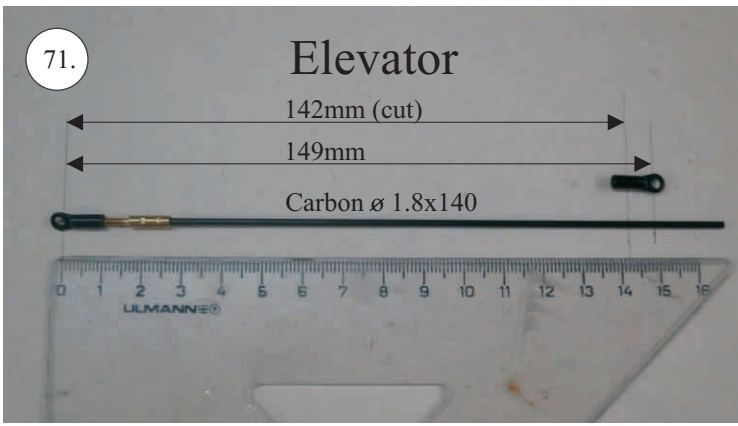

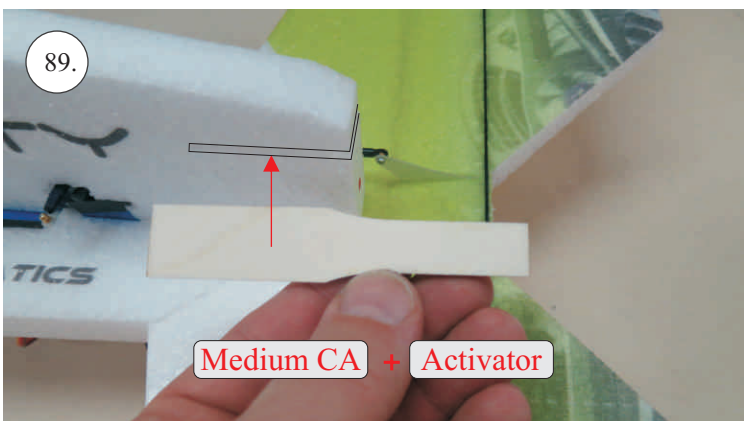
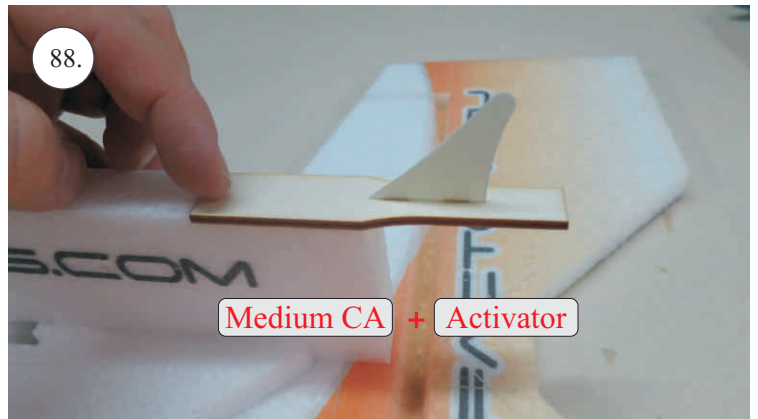
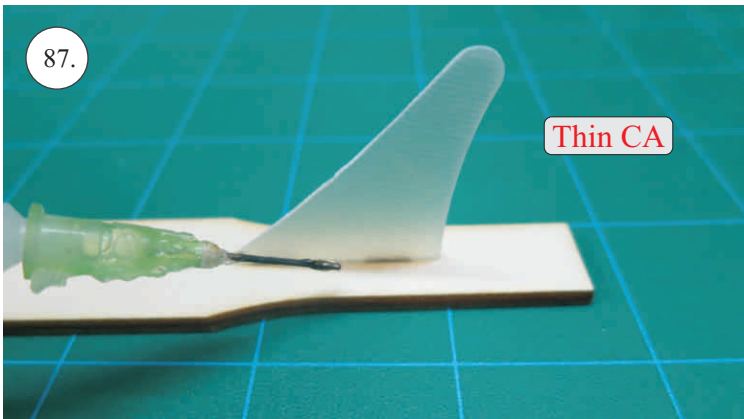
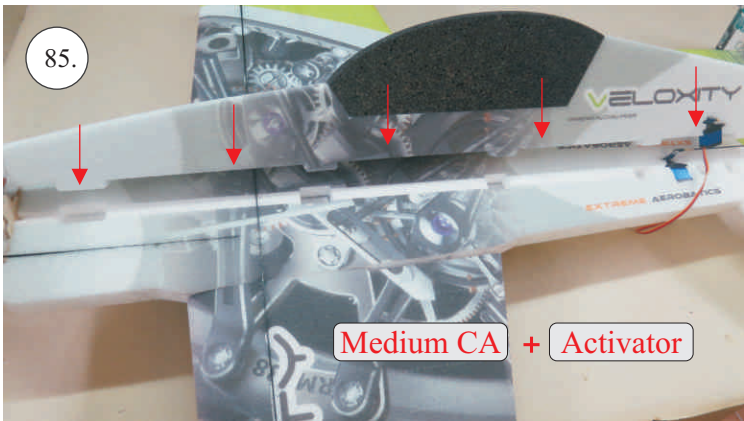
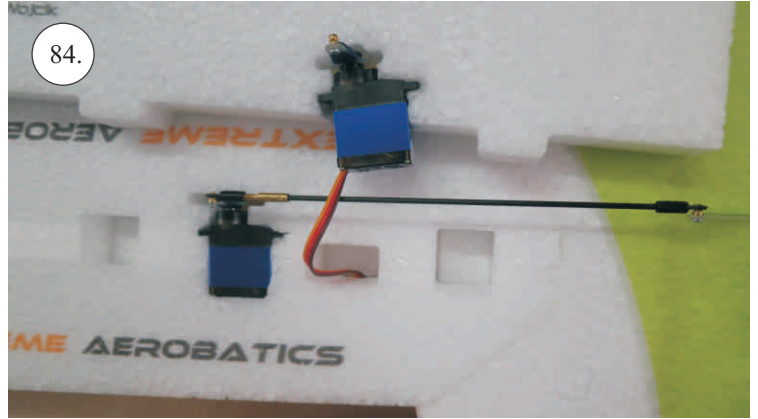
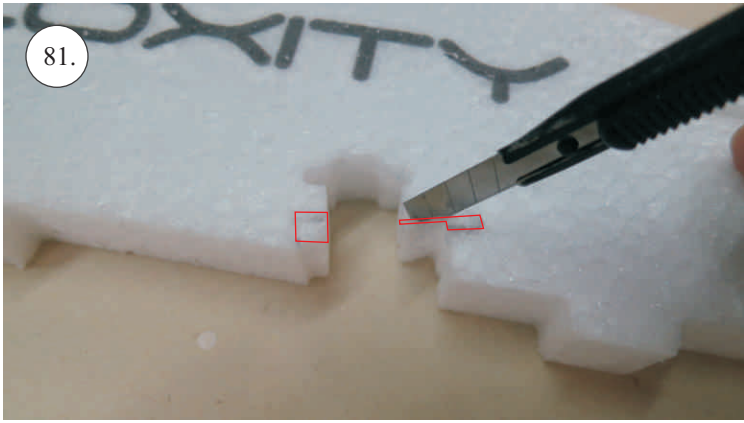



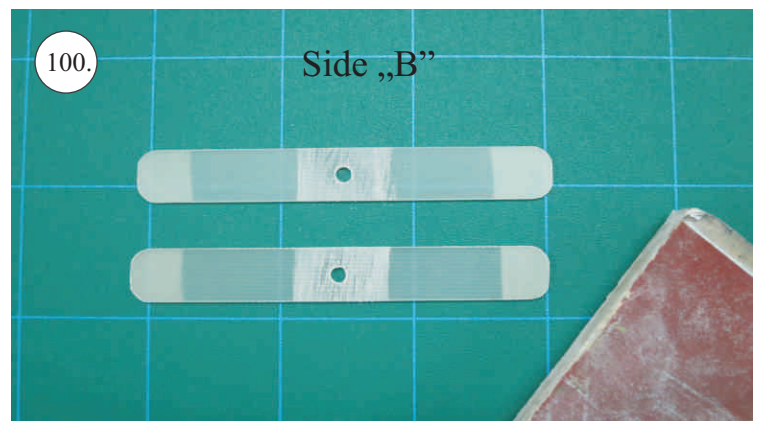
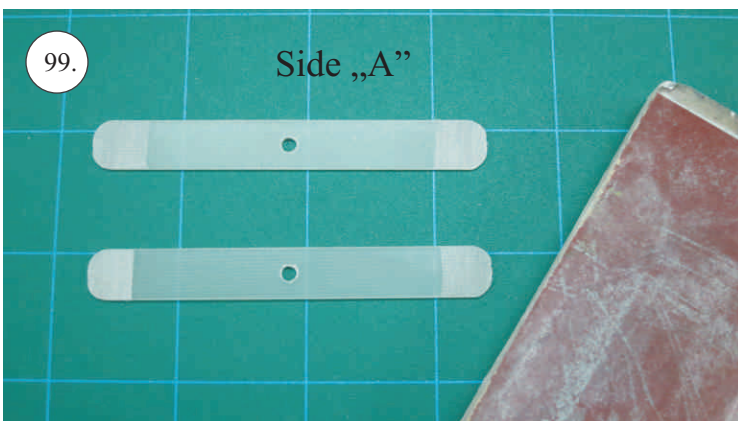
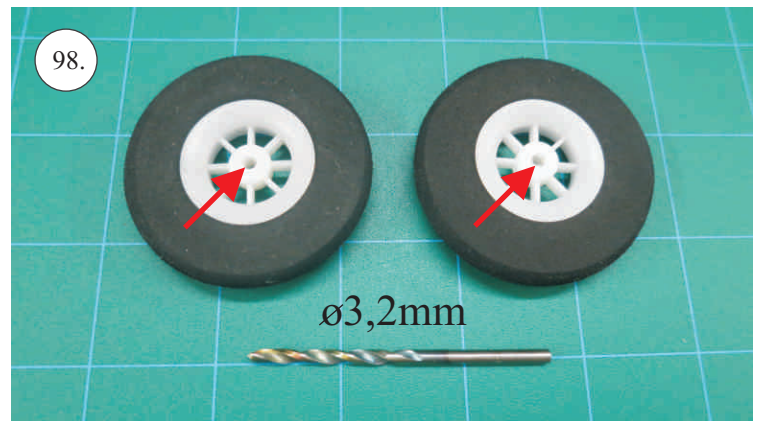
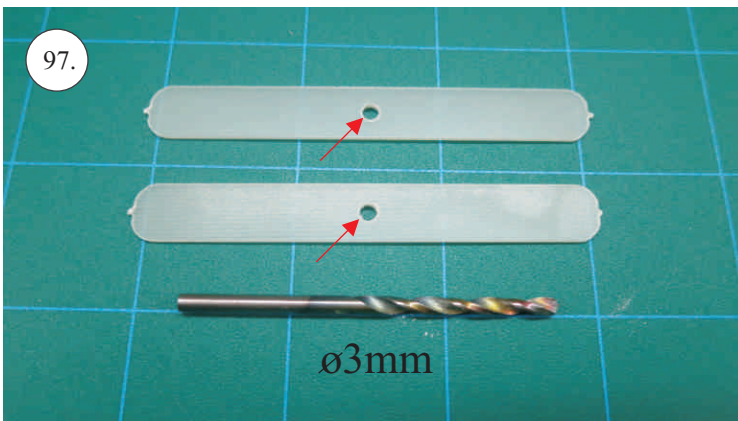
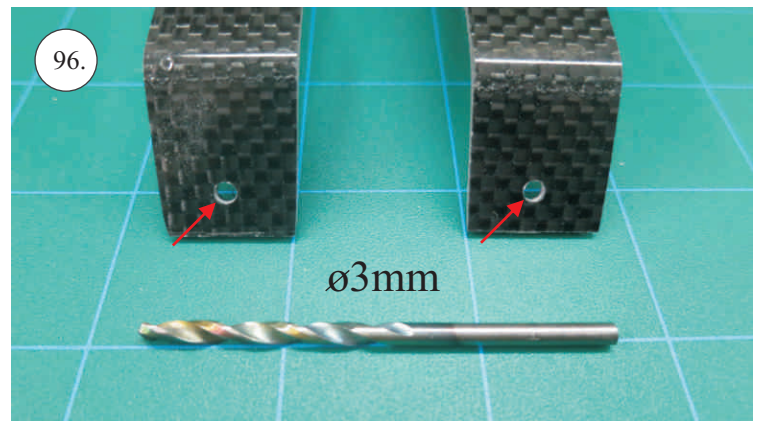
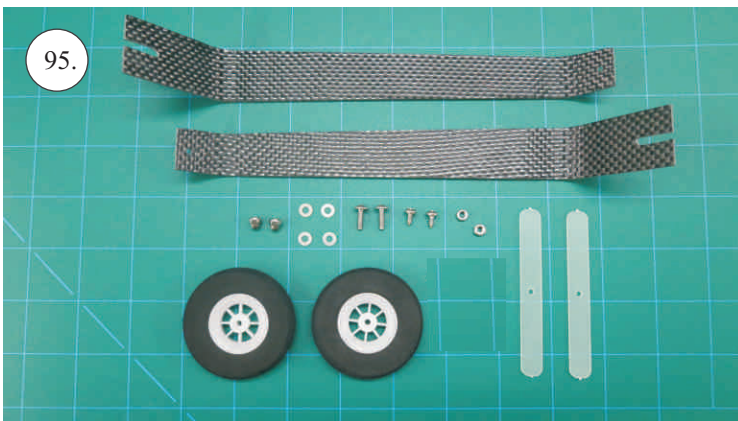
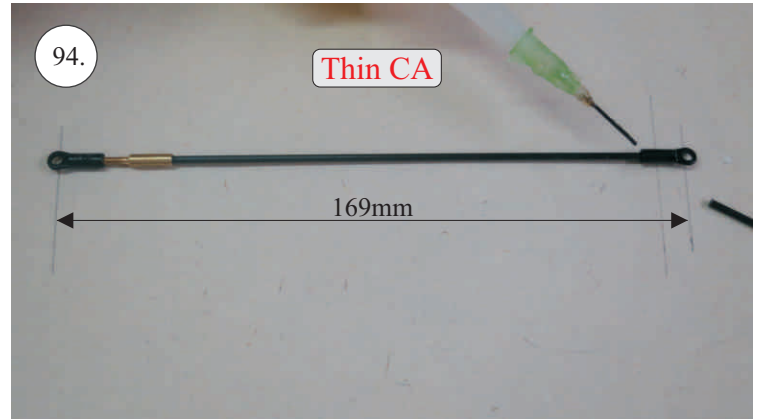
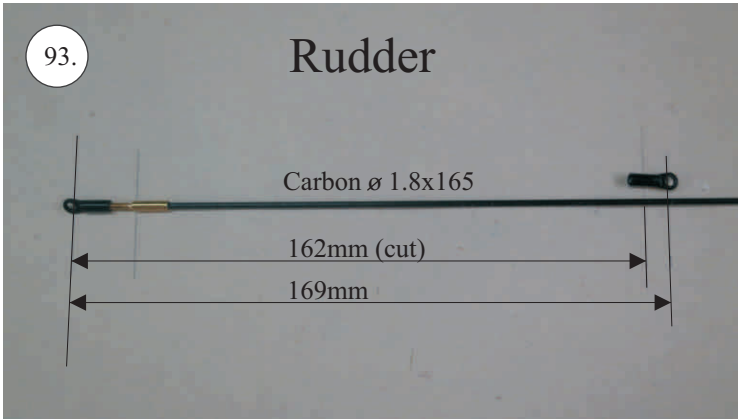
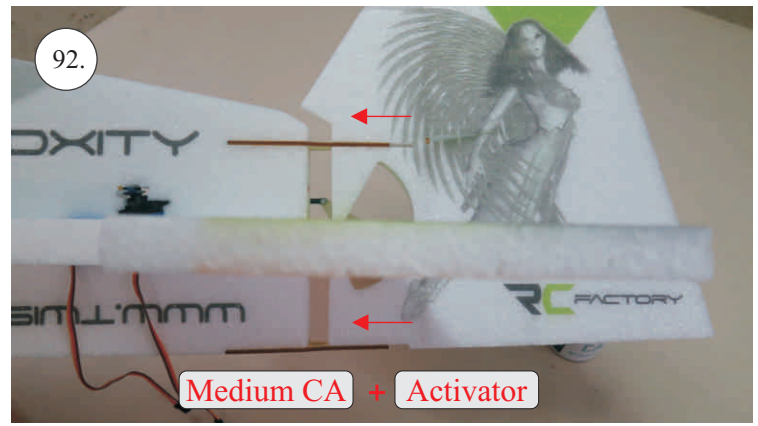
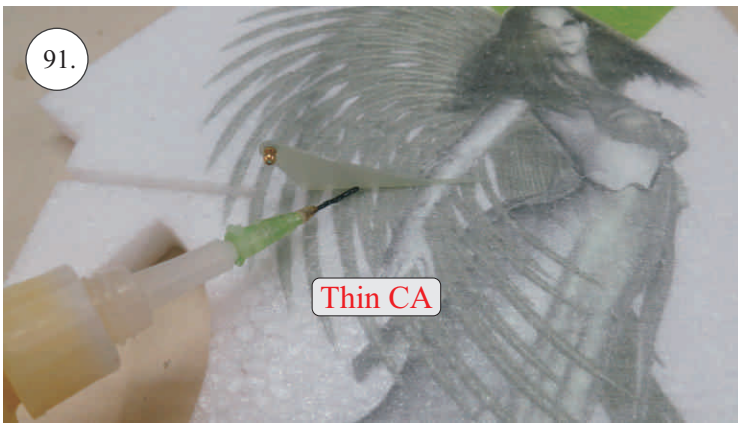



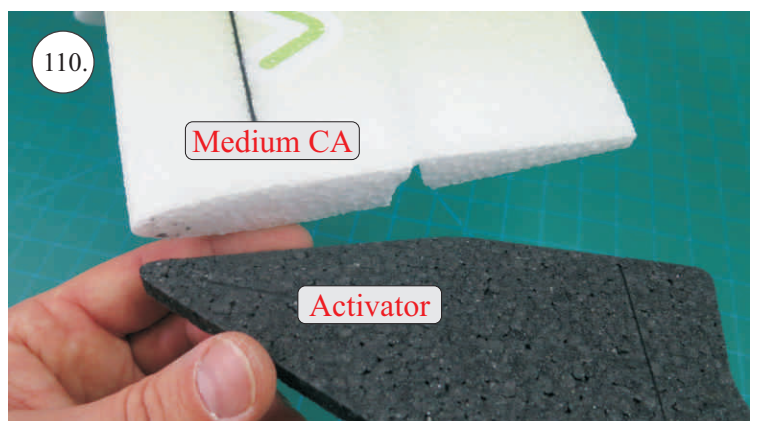
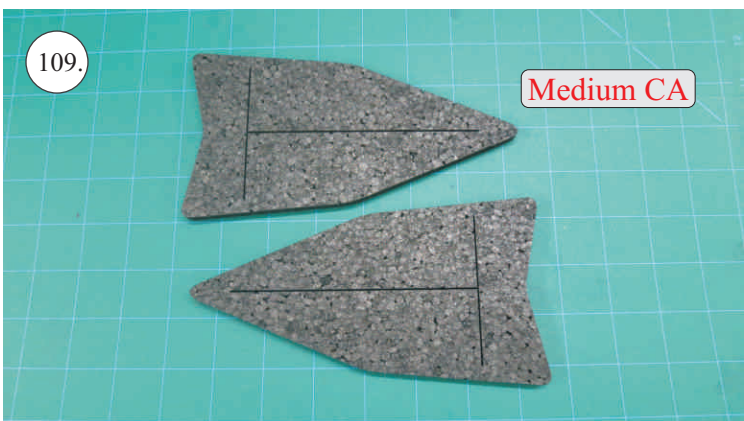
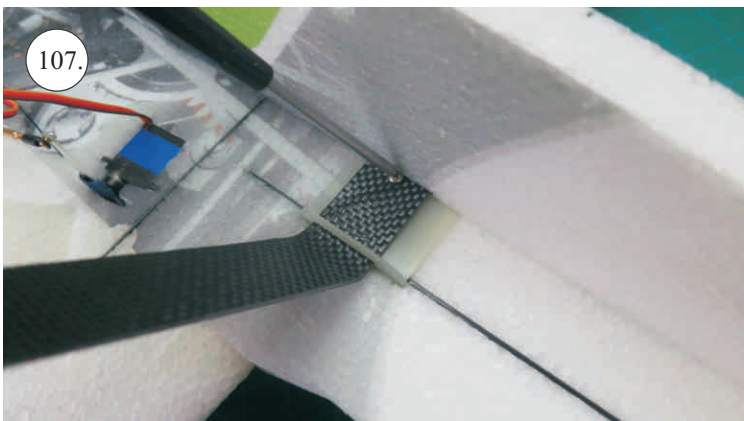
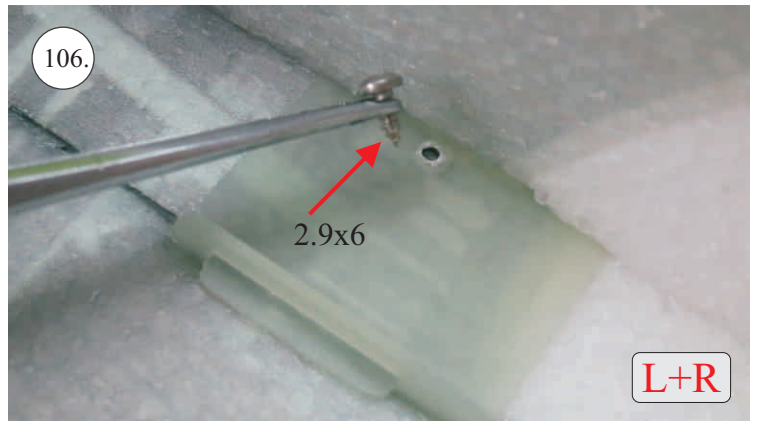
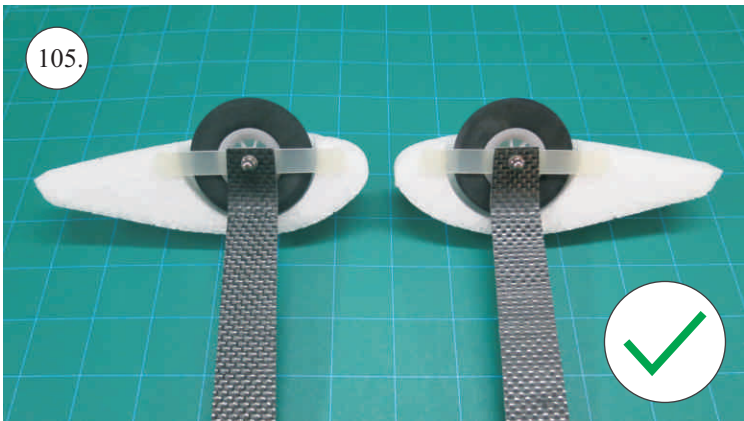
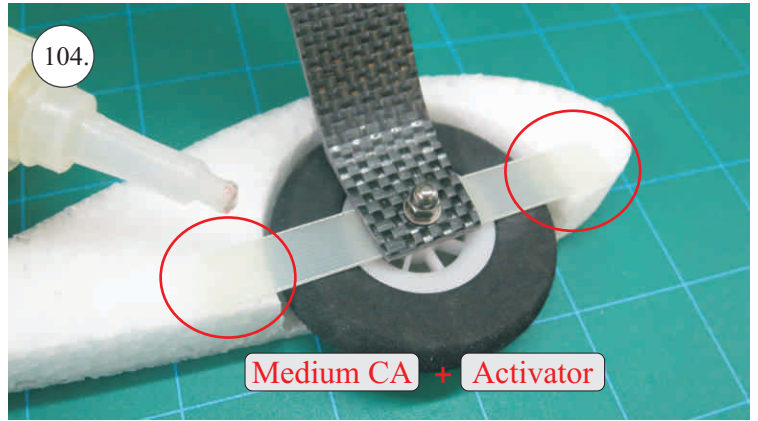
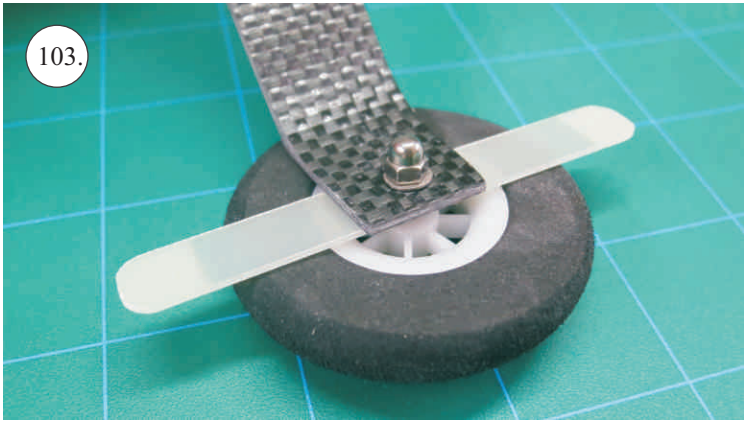
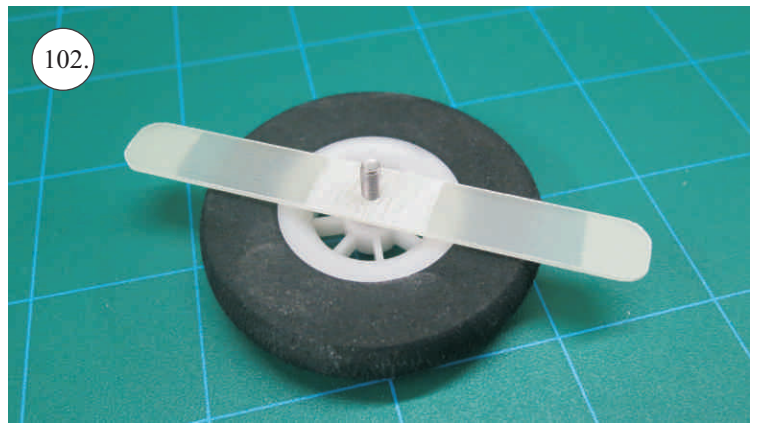
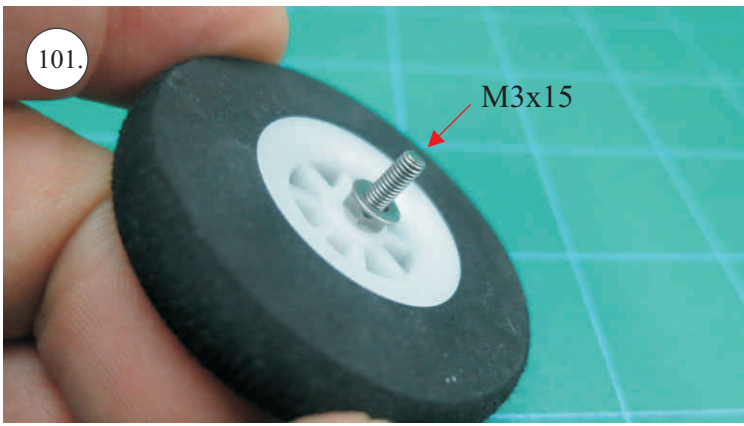



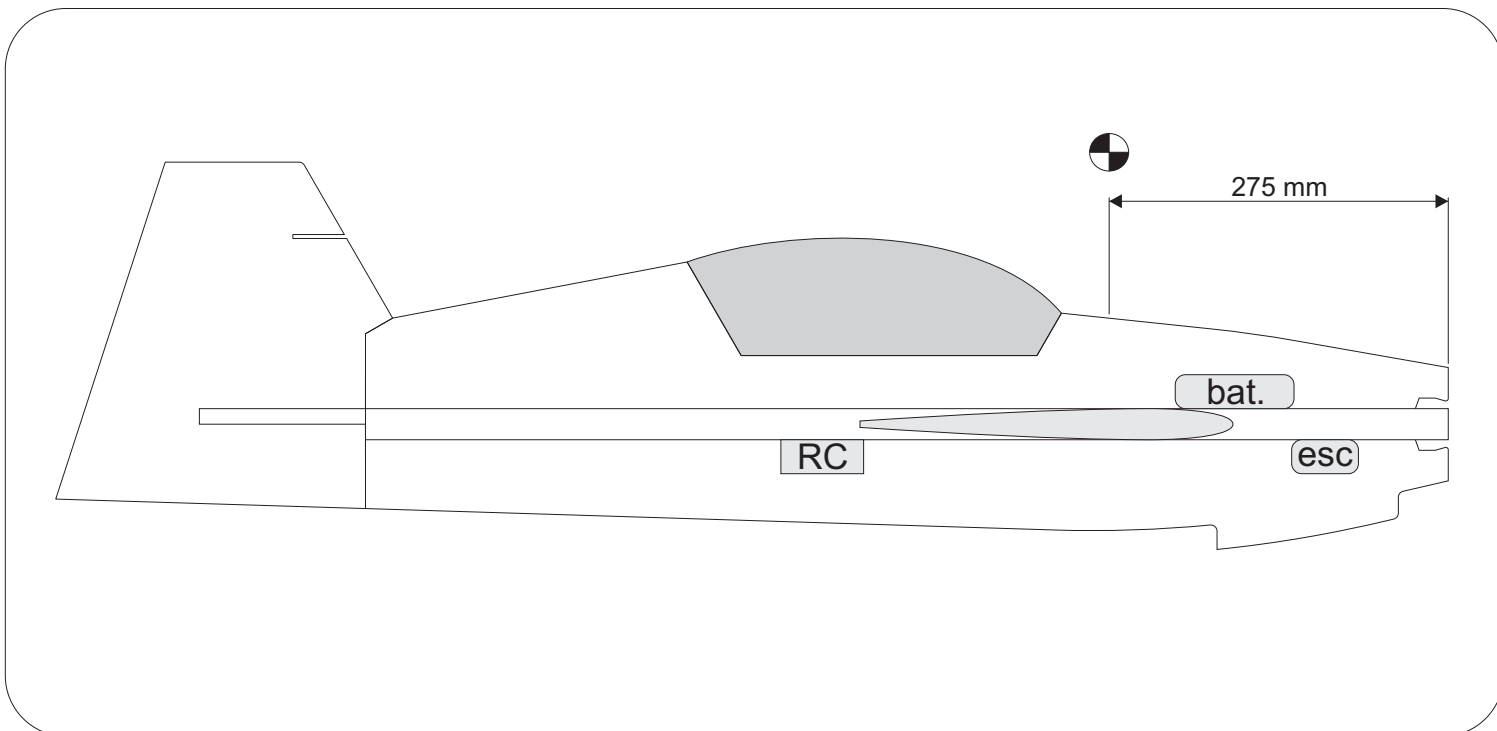
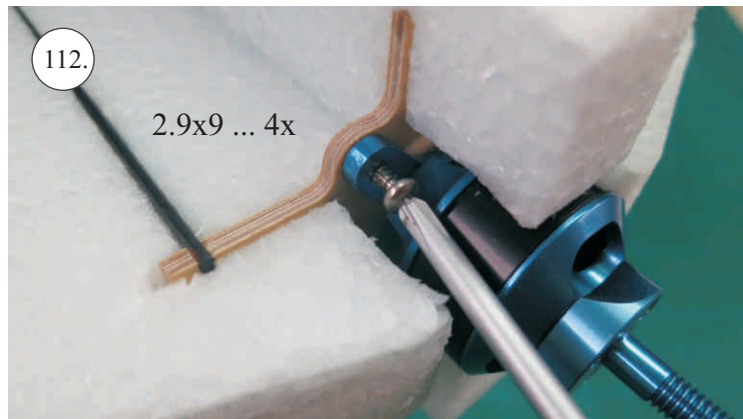
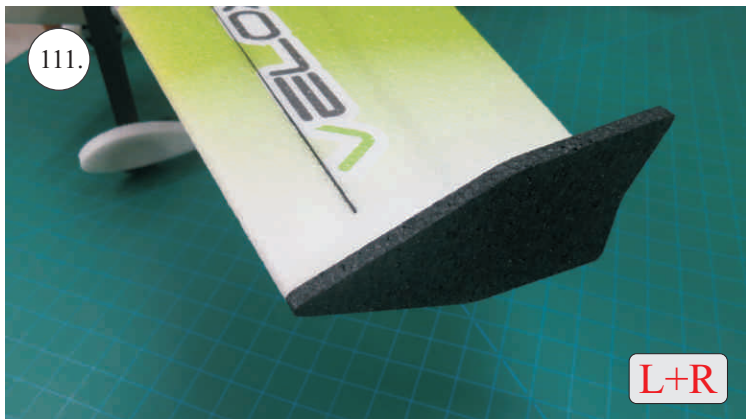

Přejeme Vám mnoho šťastných startů a přistání s modelem Velocity.

Váš RC Factory team.